

L23/30H

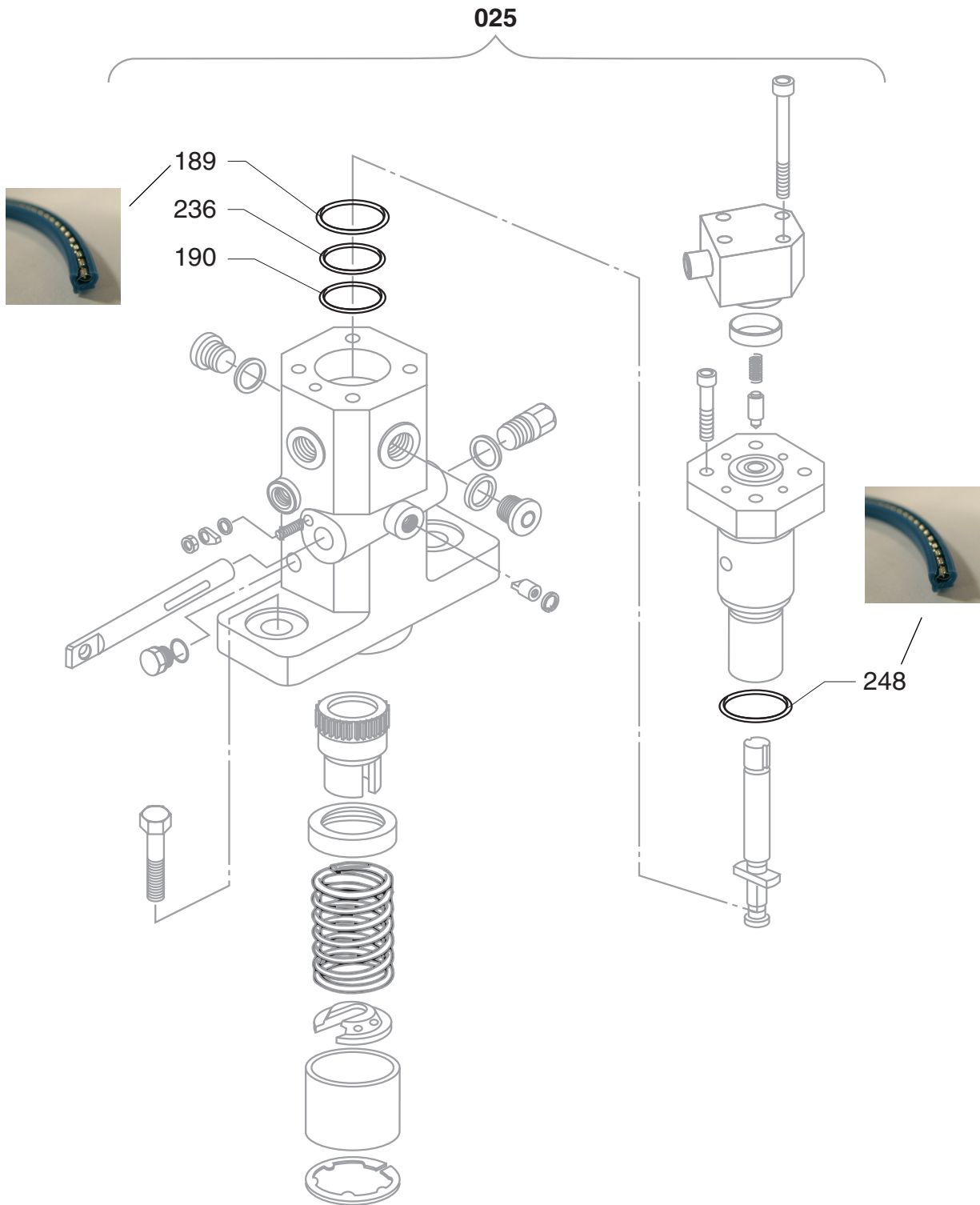

51730-12H	<b>Kit for Fuel Injection Pump, Reworked</b>	Plate Page 2 (2)
-----------	--	---------------------

**L23/30H**

Item no	Qty	Designation	Where to find in the engine instruction book	
025		Kit for fuel injection pump complete consisting of:		
	1	U-cup seal	Plate 51401	Item 189
	1	O-ring high grade viton	Plate 51401	Item 190
	1	O-ring high grade viton	Plate 51401	Item 236
	1	U-cup seal	Plate 51401	Item 248
037	1	Tools for mounting	Plate 52014	
<p><i>Please Note</i> that this is a kit supply, and that any exceeding number of o-rings and gaskets are not accepted as return goods.</p>				

08028-0D/H5250/94.08.12